



ADMOTEC 2.3GHz SMD CIRCULATOR

2250 ~ 2350 MHz

ADS230SD

Features

- | | |
|---------------------------|------------------------------|
| - Low Insertion | - Robust Design |
| - Custom Design Available | - Standard Reflow Processing |
| - RoHS Compliant | - Tape and Reel |

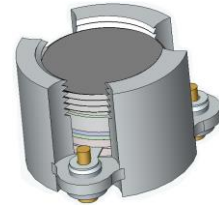

Electrical Characteristics

Parameter	Units	Specifications
Frequency	MHz	2250 ~ 2350
Insertion Loss	dB Max.	0.35
Return Loss	dB Min.	18
Isolation	dB Min.	18
Temperature	°C	-30 ~ +100
Power FWD / REV.	W Max.	30/30
PIMD (5W 2TONE)	dBc	65
Input/Output Impedance	Ω	50

Mechanical Dimensions

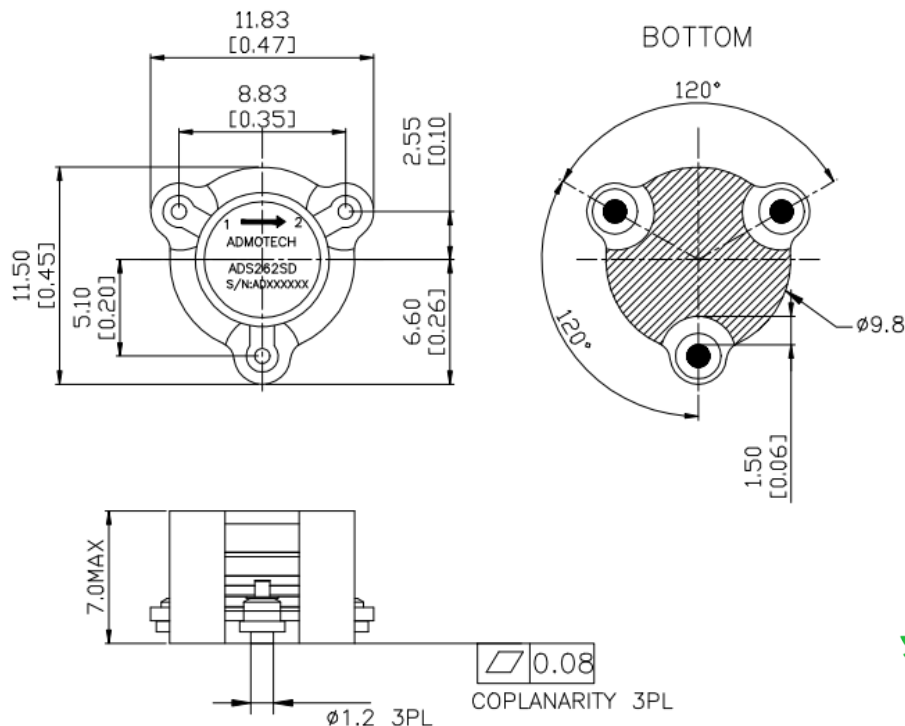

If you do not find appropriate frequency range, please contact with sales@admotech.com